

BROEN FULL FLOW DN10-50

Pålidelighed og kvalitet til moderne byggeri



New Thinking by BROEN

Hvis vi aldrig vover at tænke anderledes, sker der ikke noget nyt. Hvis vi aldrig udfordrer det, som vi kender, så går vi i stå. Hos BROEN tror vi på at afskaffe gamle vaner og løbende erstatte dem med noget bedre.

Det kalder vi New Thinking by BROEN

I al sin enkelthed handler det om – fra start til slut – at simplificere de komplekse systemer og løsninger, som du kender og sikre, at det vi leverer altid passer ind i en større sammenhæng.

Lad os derfor gøre det komplet enkelt og fortælle dig om vores værdiskabende samarbejde.

BROEN A/S er kendt for sin førende rolle indenfor ventilt teknologi. Vi tilbyder et bredt udvalg af rørsystemer, fittings og ventiler i forskellige materialer og teknologier. Løsningerne anvendes til vand-, varme-, køle-, gas- og brandsikringssystemer i bygninger – såvel beboelse, erhverv som industri.

Vi har indgående kendskab til applikationernes karakteristika, hvilket gør det muligt at udvikle innovative produkter og services, der er optimeret til nutidens behov og fremtidens krav i installationsbranchen.

BROEN A/S er certificeret efter ISO 9001.



TRAINING

BROEN tilbyder information, uddannelse og rådgivning, der vil holde dig opdateret med alle de nyeste udviklinger og løsninger.

DESIGN

BROEN har mere end 70 års erfaring at trække på og er i stand til at arbejde tæt sammen med dig og hjælpe dig gennem hele design- og projekteringsprocessen.

SUPPORT

Vores tekniske support-team er i stand til at samarbejde med ingeniører og installatører for at sikre, at det maksimale resultat og udbytte opnås i, under og efter installationsprocessen.

CARE

Vi sikrer dig service efter levering af vores produkter – fra den første kontakt og hele vejen igennem processen. Mangler du eksperthjælp og bistand, står vi parat til at hjælpe dig med at løse dit problem.

Next generation valve technology

Vi har udviklet en ny ventil, der matcher kravene til pålidelighed, effektivitet og kvalitet i moderne byggeri.

BROEN FULL FLOW byder med den nye ventil på langt flere muligheder for komplette løsninger med ensartet samlingsteknologi og materialeegenskaber.

Den nye BROEN FULL FLOW ventil er den mest fleksible ventil, der problemløst kan anvendes i utallige systemer, idet materialestandarder og teknologier er ens.



BROEN introducerer the next generation valve technology

- Alle systemer – én teknologi
- Kompakt Full Flow design
- Tilslutningsfleksibilitet
- Unik ventilidentifikation
- Dansk innovation – produceret i Danmark

DN10-50 | PN16 | Pres, gevind eller omløber

BROEN
FULL FLOW

All systems – One technology

BROEN FULL FLOW i rustfrit stål og forzinket stål – udviklet til at passe ind i enhver applikation

Brugsvand

Med BROEN FULL FLOW sikres det, at alle gældende standarder for vand- og brugsvandssystemer overholdes. BROEN FULL FLOW ventiler i rustfrit stål er korrosionsbestandige i forhold til almindeligt drikkevand. Alle metaldele i BROEN Full Flow til brugsvand er udført i syrefast rustfrit stål (AISI 316) og derved minimerer man risikoen for sammenblanding med andre materialetyper i rustfrie installationer.

Behandlet vand

BROEN FULL FLOW i rustfrit stål er særdeles velegnet til behandlet vand, hvor der stilles store krav til materialet. Alle vandberørte dele incl. kuglen er fremstillet i syrefast rustfrit stål (AISI316).

Varme

BROEN FULL FLOW ventil er den bedste løsning til varmesystemer. De kompakte ventiler gennemgår strenge kvalitetstest igennem hele produktionsprocessen og lækagetestes før de forlader fabrikken. Et energioptimeret flow design giver sammen med lasersvejsninger alle fittings en meget lav indvendig flowmodstand. Valget af BROEN FULL FLOW ventiler er det optimale valg med fokus på energieffektivitet.

Køling

BROEN FULL FLOW er fremtidens ventil til køleinstallationer. Man opnår de samme fordele som for varmeinstallationer – optimale energirigtige løsninger med lavest mulige flow modstand. Derudover har man mulighed for at tilpasse materialevalget til den enkelte installation. BROEN FULL FLOW ventiler med forhøjet fast spindel muliggør endvidere en korrekt diffusionstæt isolering af hele installationen.

Trykluft

BROEN FULL FLOW ventil kan anvendes til en lang række af forskellige typer trykluftinstallationer. Under hensyntagen til vand- og olieindhold, kan henholdsvis den forzinkede udgave anvendes – eller hvis der stilles større krav, er det muligt at anvende udgaven i rustfrit stål.





BROEN FULL FLOW – ventiler i rustfrit stål

BROEN FULL FLOW ventiler i rustfrit stål er især egnet til brugsvandsinstallationer, men kan også anvendes til andre formål, eksempelvis:

- Centralvarmesystemer
- Fjernvarmesystemer
- Kølesystemer
- Industri
- Visse former for trykluftsystemer
- Systemer for behandlet vand



BROEN FULL FLOW – ventiler i forzinket stål

BROEN FULL FLOW ventiler i forzinket stål kan anvendes til eksempelvis:

- Kølesystemer (lukkede)
- Centralvarmesystemer (lukkede)
- Fjernvarmesystemer
- Visse former for trykluftsystemer

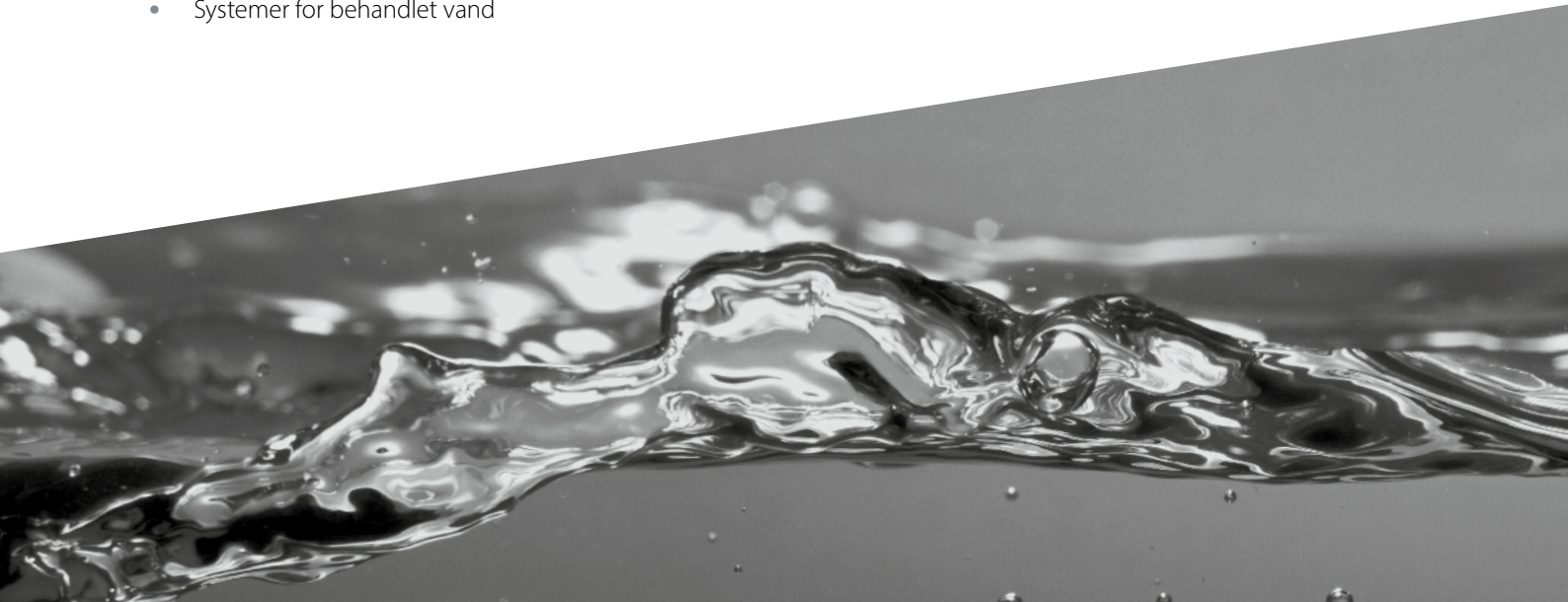



Clips

Med udskiftelige clips i håndtaget sikres nem identifikation af f.eks. koldt og varmt vand eller frem- og returløb – ligesom der kan anbringes en label i clipsen.



Greb

Det ergonomiske greb er specielt designet med fokus på nem aktivering. L-greb og T-greb er udført i glasfiberarmeret nylon støbt omkring en metalforstærkning og kan monteres i begge retninger uden brug af værktøj. Desuden fås BROEN FULL FLOW med geargreb, der ligeledes monteres uden brug af værktøj.



Tilslutningsfleksibilitet

Kombiner nemt og hurtigt BROEN FULL FLOW systemet til andre samlingsteknologier – pres, gevind eller omløber. Ventilerne passer i alle gängse rørssystemer.

Lasermærkning

BROEN FULL FLOW er som standard tydeligt lasermærket med information om størrelse, materiale og trykklasse. Derudover angiver en farvekode de forskellige materialer – grøn er rustfrit stål og rød er forzinket stål.

BROEN
FULL FLOW

All systems – One technology

BROEN FULL FLOW DN10-50 | RUSTFRIT STÅL

Tekniske data

Materiale, ventilhus:	Rustfrit stål EN 1.4404
Materiale, greb:	PA66 - glasfiberarmeret nylon med metalindlæg
Størrelser:	DN10-50
Tætninger:	PTFE*
O-ringe:	EPDM**
Tilslutninger:	Pres, muffe, nippel og omløber
Lækagesikring, pres tilslutning:	LBP - Leak Before Press
Medie:	Vand
Driftstryk:	Maks. 16 bar (Mærket med PN10 jf. EN 13828)
Driftstemperatur:	-35 °C til +135 °C
Presværktøj:	Kun godkendte presmaskiner med M-bakker eller slynger i henhold til publiceret værktøjsliste
Varmeudvidelseskoefficient:	0,0160 mm pr. mtr. $\Delta T = 1K$

* Polytetrafluorethylen ** Ethylen-propylen-dien-monomer.

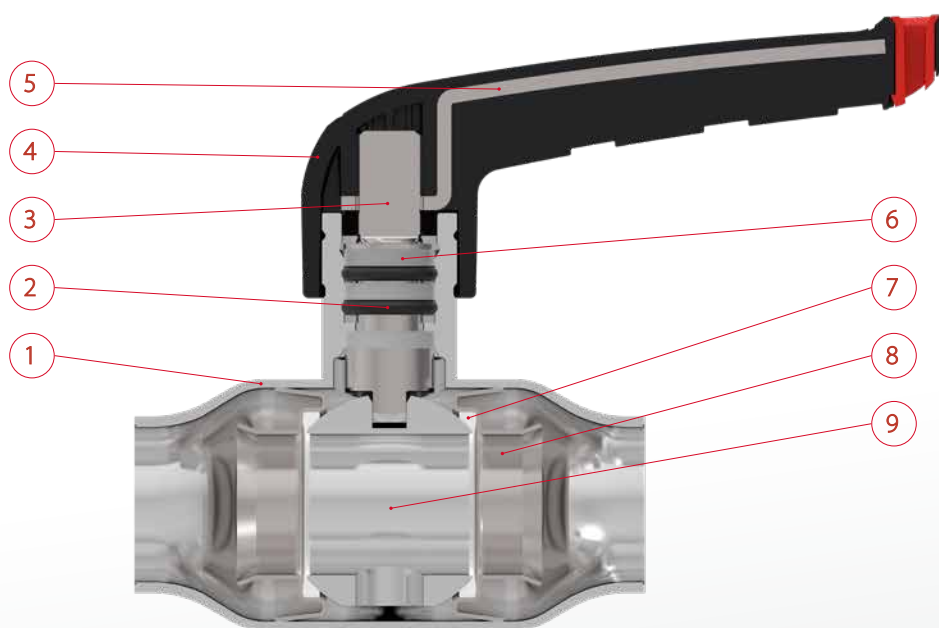

Nr.	Komponent	Materiale	Standard
1	Ventilhus	Rustfrit stål	EN 1.4404
2	O-ring	EPDM	
3	Spindel	Rustfrit stål	EN 1.4401
4	Håndtag	Glasfiberarmeret nylon	PA66
5	Metalforstærkning	Rustfrit stål	EN 1.4401

Nr.	Komponent	Materiale	Standard
6	Friktionsring	PTFE	
7	Tætning	PTFE	
8	Fjedret støttering	Rustfrit stål	EN 1.4401
9	Kugle*	Rustfrit stål	EN 1.4401

N.B.: Gevind i henhold til ISO 228/1.

* DN 32 - 50 Rustfri varianter har hul kugle

BROEN FULL FLOW DN10-50 | RUSTFRIT STÅL

Produktdata og tegninger



Øvrige produktdata og tegninger se www.broen.dk/produkter/vvs-systemloesninger eller scan QR-koden.

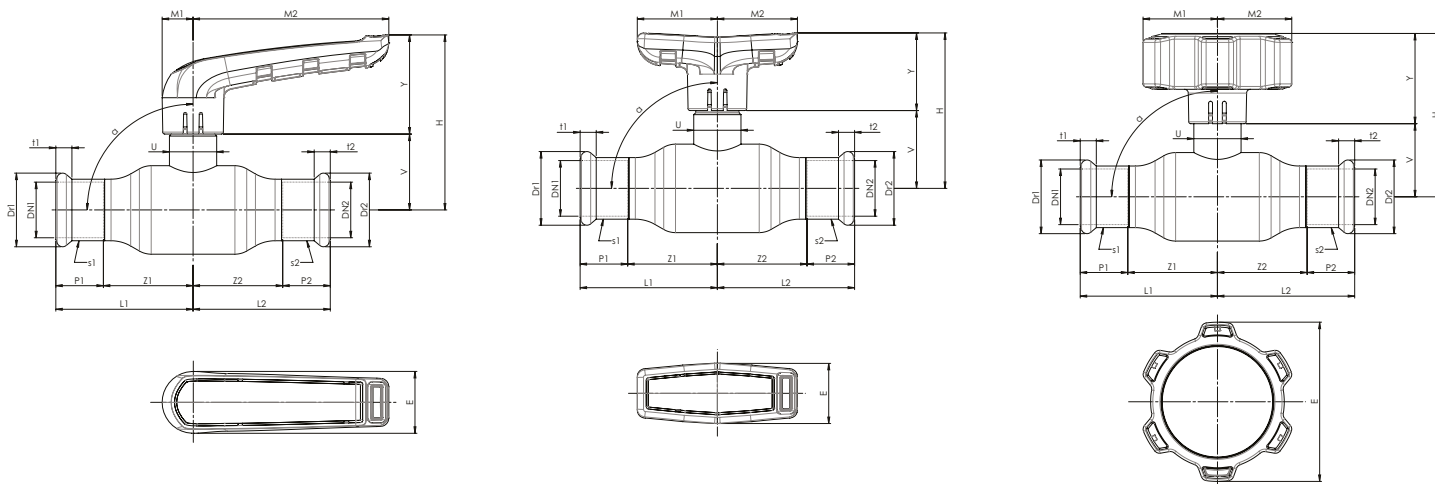

BROEN FULL FLOW DN10-50 | Pres × Pres

Pres × Pres Rustfrit stål			BF201001 Lav spindel		BF201011 Høj Spindel	
L-greb	DN	Dim.	Varenr.	VVS-nr.	Varenr.	VVS-nr.
	DN10	15 × 15	2010000100-0100	418443315	2010000101-0100	418443615
	DN15	18 × 18	2015000100-0100	418443318	2015000101-0100	418443618
	DN20	22 × 22	2020000100-0100	418443322	2020000101-0100	418443622
	DN25	28 × 28	2025000100-0100	418443328	2025000101-0100	418443628
	DN32	35 × 35	2032000100-0100	418443335	2032000101-0100	418443635
	DN40	42 × 42	2040000100-0100	418443342	2040000101-0100	418443642
DN50	54 × 54	2050000100-0100	418443354	2050000101-0100	418443654	

Pres × Pres Rustfrit stål			BF201004 Lav spindel		BF201014 Høj Spindel	
T-greb	DN	Dim.	Varenr.	VVS-nr.	Varenr.	VVS-nr.
	DN10	15 × 15	2010000100-0400	418443515	2010000101-0400	418443815
	DN15	18 × 18	2015000100-0400	418443518	2015000101-0400	418443818
	DN20	22 × 22	2020000100-0400	418443522	2020000101-0400	418443822
	DN25	28 × 28	2025000100-0400	418443528	2025000101-0400	418443828
	DN32	35 × 35	2032000100-0400	418443535	2032000101-0400	418443835

Pres × Pres Rustfrit stål			BF201002 Lav spindel		BF201012 Høj Spindel	
Gear-greb	DN	Dim.	Varenr.	VVS-nr.	Varenr.	VVS-nr.
	DN10	15 × 15	2010000100-0200	418443415	2010000101-0200	418443715
	DN15	18 × 18	2015000100-0200	418443418	2015000101-0200	418443718
	DN20	22 × 22	2020000100-0200	418443422	2020000101-0200	418443722
	DN25	28 × 28	2025000100-0200	418443428	2025000101-0200	418443728
	DN32	35 × 35	2032000100-0200	418443435	2032000101-0200	418443735
	DN40	42 × 42	2040000100-0200	418443442	2040000101-0200	418443742
DN50	54 × 54	2050000100-0200	418443454	2050000101-0200	418443754	

BROEN FULL FLOW DN10-50 | Pres × Muffe

Pres × Muffe Rustfrit stål			BF210001 Lav spindel		BF210011 Høj Spindel	
L-greb	DN	Dim.	Varenr.	VVS-nr.	Varenr.	VVS-nr.
	DN10	1/2" × 15	2010001010-0100	418444315	2010001011-0100	418444615
	DN15	3/4" × 18	2015001010-0100	418444318	2015001011-0100	418444618
	DN20	3/4" × 22	2020001000-0100	418444322	2020001001-0100	418444622
	DN25	1" × 28	2025001000-0100	418444328	2025001001-0100	418444628
	DN32	1 1/4" × 35	2032001000-0100	418444335	2032001001-0100	418444635
	DN40	1 1/2" × 42	2040001000-0100	418444342	2040001001-0100	418444642
	DN50	2" × 54	2050001000-0100	418444354	2050001001-0100	418444654

Pres × Muffe Rustfrit stål			BF210004 Lav spindel		BF210014 Høj Spindel	
T-greb	DN	Dim.	Varenr.	VVS-nr.	Varenr.	VVS-nr.
	DN10	1/2" × 15	2010001010-0400	418444515	2010001011-0400	418444815
	DN15	3/4" × 18	2015001010-0400	418444518	2015001011-0400	418444818
	DN20	3/4" × 22	2020001000-0400	418444522	2020001001-0400	418444822
	DN25	1" × 28	2025001000-0400	418444528	2025001001-0400	418444828
	DN32	1 1/4" × 35	2032001000-0400	418444535	2032001001-0400	418444835

Pres × Muffe Rustfrit stål			BF210002 Lav spindel		BF210012 Høj Spindel	
Gear-greb	DN	Dim.	Varenr.	VVS-nr.	Varenr.	VVS-nr.
	DN10	1/2" × 15	2010001010-0200	418444415	2010001011-0200	418444715
	DN15	3/4" × 18	2015001010-0200	418444418	2015001011-0200	418444718
	DN20	3/4" × 22	2020001000-0200	418444422	2020001001-0200	418444722
	DN25	1" × 28	2025001000-0200	418444428	2025001001-0200	418444728
	DN32	1 1/4" × 35	2032001000-0200	418444435	2032001001-0200	418444735
	DN40	1 1/2" × 42	2040001000-0200	418444442	2040001001-0200	418444742
	DN50	2" × 54	2050001000-0200	418444454	2050001001-0200	418444754

BROEN FULL FLOW DN10-50 | Pres × Nippel

Pres × Nippel Rustfrit stål			BF212001 Lav spindel		BF212011 Høj Spindel	
L-greb	DN	Dim.	Varenr.	VVS-nr.	Varenr.	VVS-nr.
	DN10	1/2" × 15	2010001210-0100	418446315	2010001211-0100	418446615
	DN15	3/4" × 18	2015001210-0100	418446318	2015001211-0100	418446618
	DN20	3/4" × 22	2020001200-0100	418446322	2020001201-0100	418446622
	DN25	1" × 28	2025001200-0100	418446328	2025001201-0100	418446628
	DN32	1 1/4" × 35	2032001200-0100	418446335	2032001201-0100	418446635
	DN40	1 1/2" × 42	2040001200-0100	418446342	2040001201-0100	418446642
	DN50	2" × 54	2050001200-0100	418446354	2050001201-0100	418446654

Pres × Nippel Rustfrit stål			BF212004 Lav spindel		BF212014 Høj Spindel	
T-greb	DN	Dim.	Varenr.	VVS-nr.	Varenr.	VVS-nr.
	DN10	1/2" × 15	2010001210-0400	418440503	2010001211-0400	418440803
	DN15	3/4" × 18	2015001210-0400	418440504	2015001211-0400	418440804
	DN20	3/4" × 22	2020001200-0400	418440506	2020001201-0400	418440806
	DN25	1" × 28	2025001200-0400	418440508	2025001201-0400	418440808
	DN32	1 1/4" × 35	2032001200-0400	418440510	2032001201-0400	418440810

Pres x Nippel Rustfrit stål			BF212002 Lav spindel		BF212012 Høj Spindel	
Gear-greb	DN	Dim.	Varenr.	VVS-nr.	Varenr.	VVS-nr.
	DN10	1/2" x 15	2010001210-0200	418440403	2010001211-0200	418440703
	DN15	3/4" x 18	2015001210-0200	418440404	2015001211-0200	418440704
	DN20	3/4" x 22	2020001200-0200	418440406	2020001201-0200	418440706
	DN25	1" x 28	2025001200-0200	418440408	2025001201-0200	418440708
	DN32	1 1/4" x 35	2032001200-0200	418440410	2032001201-0200	418440710
	DN40	1 1/2" x 42	2040001200-0200	418440411	2040001201-0200	418440711
	DN50	2" x 54	2050001200-0200	418440412	2050001201-0200	418440712

BROEN FULL FLOW DN10-50 | Pres x Omløber

Pres x Omløber Rustfrit stål			BF214001 Lav spindel		BF214011 Høj Spindel	
L-greb	DN	Dim.	Varenr.	VVS-nr.	Varenr.	VVS-nr.
	DN10	3/4" x 15	2010001410-0100	418445315	2010001411-0100	418445615
	DN15	3/4" x 18	2015001400-0100	418445318	2015001401-0100	418445618
	DN20	3/4" x 22	2020001410-0100	418445322	2020001411-0100	418445622
	DN25	1 1/4" x 28	2025001400-0100	418445328	2025001401-0100	418445628
	DN32	1 1/2" x 35	2032001400-0100	418445335	2032001401-0100	418445635
	DN40	1 3/4" x 42	2040001400-0100	418445342	2040001401-0100	418445642
	DN50	2 1/4" x 54	2050001400-0100	418445354	2050001401-0100	418445654

Pres x Omløber Rustfrit stål			BF214004 Lav spindel		BF214014 Høj Spindel	
T-greb	DN	Dim.	Varenr.	VVS-nr.	Varenr.	VVS-nr.
	DN10	3/4" x 15	2010001410-0400	418445515	2010001411-0400	418445815
	DN15	3/4" x 18	2015001400-0400	418445518	2015001401-0400	418445818
	DN20	3/4" x 22	2020001410-0400	418445522	2020001411-0400	418445822
	DN25	1 1/4" x 28	2025001400-0400	418445528	2025001401-0400	418445828
	DN32	1 1/2" x 35	2032001400-0400	418445535	2032001401-0400	418445835

Pres x Omløber Rustfrit stål			BF214002 Lav spindel		BF214012 Høj Spindel	
Gear-greb	DN	Dim.	Varenr.	VVS-nr.	Varenr.	VVS-nr.
	DN10	3/4" x 15	2010001410-0200	418445415	2010001411-0200	418445715
	DN15	3/4" x 18	2015001400-0200	418445418	2015001401-0200	418445718
	DN20	3/4" x 22	2020001410-0200	418445422	2020001411-0200	418445722
	DN25	1 1/4" x 28	2025001400-0200	418445428	2025001401-0200	418445728
	DN32	1 1/2" x 35	2032001400-0200	418445435	2032001401-0200	418445735
	DN40	1 3/4" x 42	2040001400-0200	418445442	2040001401-0200	418445742
	DN50	2 1/4" x 54	2050001400-0200	418445454	2050001401-0200	418445754

BROEN FULL FLOW DN10-50 | Muffe x Muffe

Muffe x Muffe Rustfrit stål			BF220001 Lav spindel		BF220011 Høj Spindel	
L-greb	DN	Dim.	Varenr.	VVS-nr.	Varenr.	VVS-nr.
	DN10	3/8" x 3/8"	2010002000-0100	418440303	2010002001-0100	418440603
	DN15	1/2" x 1/2"	2015002000-0100	418440304	2015002001-0100	418440604
	DN20	3/4" x 3/4"	2020002000-0100	418440306	2020002001-0100	418440606
	DN25	1" x 1"	2025002000-0100	418440308	2025002001-0100	418440608
	DN32	1 1/4" x 1 1/4"	2032002000-0100	418440310	2032002001-0100	418440610
	DN40	1 1/2" x 1 1/2"	2040002000-0100	418440311	2040002001-0100	418440611
	DN50	2" x 2"	2050002000-0100	418440312	2050002001-0100	418440612

Muffe × Muffe Rustfrit stål			BF220004 Lav spindel		BF220014 Høj Spindel	
T-greb	DN	Dim.	Varenr.	VVS-nr.	Varenr.	VVS-nr.
	DN10	3/8" × 3/8"	2010002000-0400	418446515	2010002001-0400	418446815
	DN15	1/2" × 1/2"	2015002000-0400	418446518	2015002001-0400	418446818
	DN20	3/4" × 3/4"	2020002000-0400	418446522	2020002001-0400	418446822
	DN25	1" × 1"	2025002000-0400	418446528	2025002001-0400	418446828
	DN32	1 1/4" × 1 1/4"	2032002000-0400	418446535	2032002001-0400	418446835

Muffe × Muffe Rustfrit stål			BF220002 Lav spindel		BF220012 Høj Spindel	
Gear-greb	DN	Dim.	Varenr.	VVS-nr.	Varenr.	VVS-nr.
	DN10	3/8" × 3/8"	2010002000-0200	418446415	2010002001-0200	418446715
	DN15	1/2" × 1/2"	2015002000-0200	418446418	2015002001-0200	418446718
	DN20	3/4" × 3/4"	2020002000-0200	418446422	2020002001-0200	418446722
	DN25	1" × 1"	2025002000-0200	418446428	2025002001-0200	418446728
	DN32	1 1/4" × 1 1/4"	2032002000-0200	418446435	2032002001-0200	418446735
	DN40	1 1/2" × 1 1/2"	2040002000-0200	418446442	2040002001-0200	418446742
	DN50	2" × 2"	2050002000-0200	418446454	2050002001-0200	418446754

BROEN FULL FLOW DN10-50 | Muffe × Omløber

Muffe × Omløber Rustfrit stål			BF222001 Lav spindel		BF222011 Høj Spindel	
L-greb	DN	Dim.	Varenr.	VVS-nr.	Varenr.	VVS-nr.
	DN10	1/2" × 3/8"	2010002200-0100	418442318	2010002201-0100	418442618
	DN15	3/4" × 1/2"	2015002200-0100	418442327	2015002201-0100	418442627
	DN20	3/4" × 3/4"	2020002210-0100	418442306	2020002211-0100	418442606
	DN20	1" × 3/4"	2020002200-0100	418442335	2020002201-0100	418442635
	DN25	1 1/4" × 1"	2025002200-0100	418442344	2025002201-0100	418442644
	DN32	1 1/2" × 1 1/4"	2032002200-0100	418442352	2032002201-0100	418442652
	DN40	2" × 1 1/2"	2040002210-0100	418442360	2040002211-0100	418442660
	DN50	2 1/4" × 2"	2050002200-0100	418442369	2050002201-0100	418442669

Muffe × Omløber Rustfrit stål			BF222004 Lav spindel		BF222014 Høj Spindel	
T-greb	DN	Dim.	Varenr.	VVS-nr.	Varenr.	VVS-nr.
	DN10	1/2" × 3/8"	2010002200-0400	418442518	2010002201-0400	418442818
	DN15	3/4" × 1/2"	2015002200-0400	418442527	2015002201-0400	418442827
	DN20	1" × 3/4"	2020002200-0400	418442535	2020002201-0400	418442835
	DN25	1 1/4" × 1"	2025002200-0400	418442544	2025002201-0400	418442844
	DN32	1 1/2" × 1 1/4"	2032002200-0400	418442552	2032002201-0400	418442852

Muffe × Omløber Rustfrit stål			BF222002 Lav spindel		BF222012 Høj Spindel	
Gear-greb	DN	Dim.	Varenr.	VVS-nr.	Varenr.	VVS-nr.
	DN10	1/2" × 3/8"	2010002200-0200	418442418	2010002201-0200	418442718
	DN15	3/4" × 1/2"	2015002200-0200	418442427	2015002201-0200	418442727
	DN20	1" × 3/4"	2020002200-0200	418442435	2020002201-0200	418442735
	DN25	1 1/4" × 1"	2025002200-0200	418442444	2025002201-0200	418442744
	DN32	1 1/2" × 1 1/4"	2032002200-0200	418442452	2032002201-0200	418442752
	DN40	2" × 1 1/2"	2040002210-0200	418442460	2040002211-0200	418442760
	DN50	2 1/4" × 2"	2050002200-0200	418442469	2050002201-0200	418442769

BROEN FULL FLOW DN10-50 | Muffe x Nippel

Muffe x Nippel Rustfrit stål			BF224001 Lav spindel		BF224011 Høj Spindel	
L-greb	DN	Dim.	Varenr.	VVS-nr.	Varenr.	VVS-nr.
	DN10	3/8" x 3/8"	2010002400-0100	418441303	2010002401-0100	418441603
	DN15	1/2" x 1/2"	2015002400-0100	418441304	2015002401-0100	418441604
	DN20	3/4" x 3/4"	2020002400-0100	418441306	2020002401-0100	418441606
	DN25	1" x 1"	2025002400-0100	418441308	2025002401-0100	418441608
	DN32	1 1/4" x 1 1/4"	2032002400-0100	418441310	2032002401-0100	418441610
	DN40	1 1/2" x 1 1/2"	2040002400-0100	418441311	2040002401-0100	418441611
	DN50	2" x 2"	2050002400-0100	418441312	2050002401-0100	418441612

Muffe x Nippel Rustfrit stål			BF224004 Lav spindel		BF224014 Høj Spindel	
T-greb	DN	Dim.	Varenr.	VVS-nr.	Varenr.	VVS-nr.
	DN10	3/8" x 3/8"	2010002400-0400	418441503	2010002401-0400	418441803
	DN15	1/2" x 1/2"	2015002400-0400	418441504	2015002401-0400	418441804
	DN20	3/4" x 3/4"	2020002400-0400	418441506	2020002401-0400	418441806
	DN25	1" x 1"	2025002400-0400	418441508	2025002401-0400	418441808
	DN32	1 1/4" x 1 1/4"	2032002400-0400	418441510	2032002401-0400	418441810

Muffe x Nippel Rustfrit stål			BF224002 Lav spindel		BF224012 Høj Spindel	
Gear-greb	DN	Dim.	Varenr.	VVS-nr.	Varenr.	VVS-nr.
	DN10	3/8" x 3/8"	2010002400-0200	418441403	2010002401-0200	418441703
	DN15	1/2" x 1/2"	2015002400-0200	418441404	2015002401-0200	418441704
	DN20	3/4" x 3/4"	2020002400-0200	418441406	2020002401-0200	418441706
	DN25	1" x 1"	2025002400-0200	418441408	2025002401-0200	418441708
	DN32	1 1/4" x 1 1/4"	2032002400-0200	418441410	2032002401-0200	418441710
	DN40	1 1/2" x 1 1/2"	2040002400-0200	418441411	2040002401-0200	418441711
	DN50	2" x 2"	2050002400-0200	418441412	2050002401-0200	418441712

BROEN FULL FLOW DN10-50 | FORZINKET STÅL

Tekniske data

Materiale, ventilhus:	P235GH iht. EN 10217-2
Materiale, greb:	PA66 - glasfiberarmeret nylon med metalindlæg
Størrelser:	DN10-50
Tætninger:	PTFE*
O-ringe:	EPDM**
Tilslutninger:	Pres, muffe, nippel og omløber
Lækagesikring, pres tilslutning:	LBP - Leak Before Press
Medie:	Vand
Driftstryk:	Maks. 16 bar
Driftstemperatur:	-35 °C til +135 °C
Presværktøj:	Kun godkendte presmaskiner med M-bakker eller slynger i henhold til publiceret værktøjsliste
Varmeudvidelseskoefficient:	0,0108 mm pr. mtr. $\Delta T = 1K$

* Polytetrafluorethylen ** Ethylen-propylen-dien-monomer.

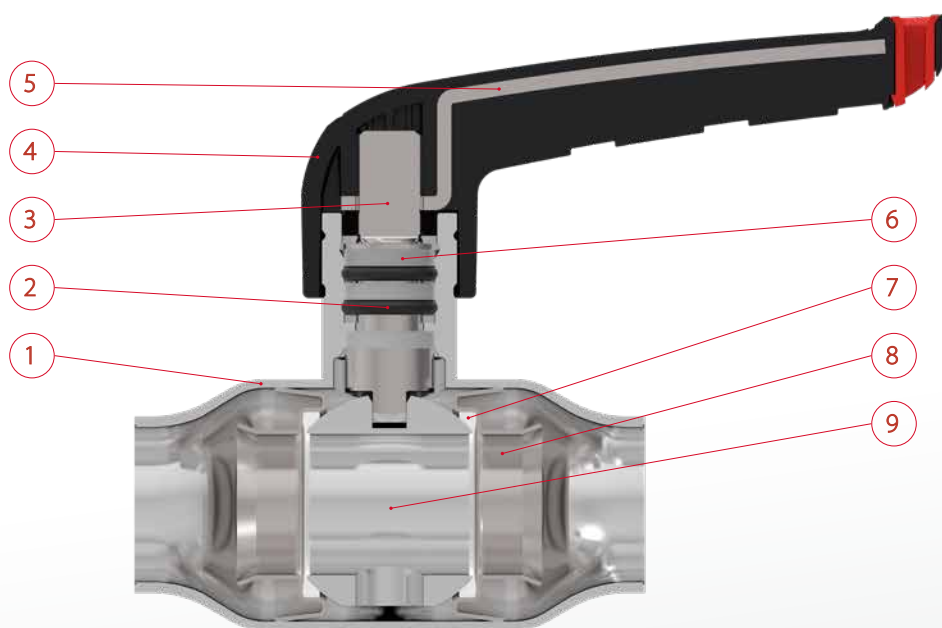

Nr.	Komponent	Materiale	Standard
1	Ventilhus	Forzinket stål - P235GH	EN 10217-2
2	O-ring	EPDM	
3	Spindel	Rustfrit stål	EN 1.4401
4	Håndtag	Glasfiberarmeret nylon	PA66
5	Metalforstærkning	Galvaniseret stål	

Nr.	Komponent	Materiale	Standard
6	Friktionsring	PTFE	
7	Tætning	PTFE	
8	Fjedret støttering	Rustfrit stål	EN 1.4401
9	Kugle	Messing	CW617N

N.B.: Gevind i henhold til ISO 228/1.

BROEN FULL FLOW DN10-50 | FORZINKET STÅL

Produktdata og tegninger



Øvrige produktdata og tegninger se www.broen.dk/produkter/vvs-systemloesninger eller scan QR-koden.

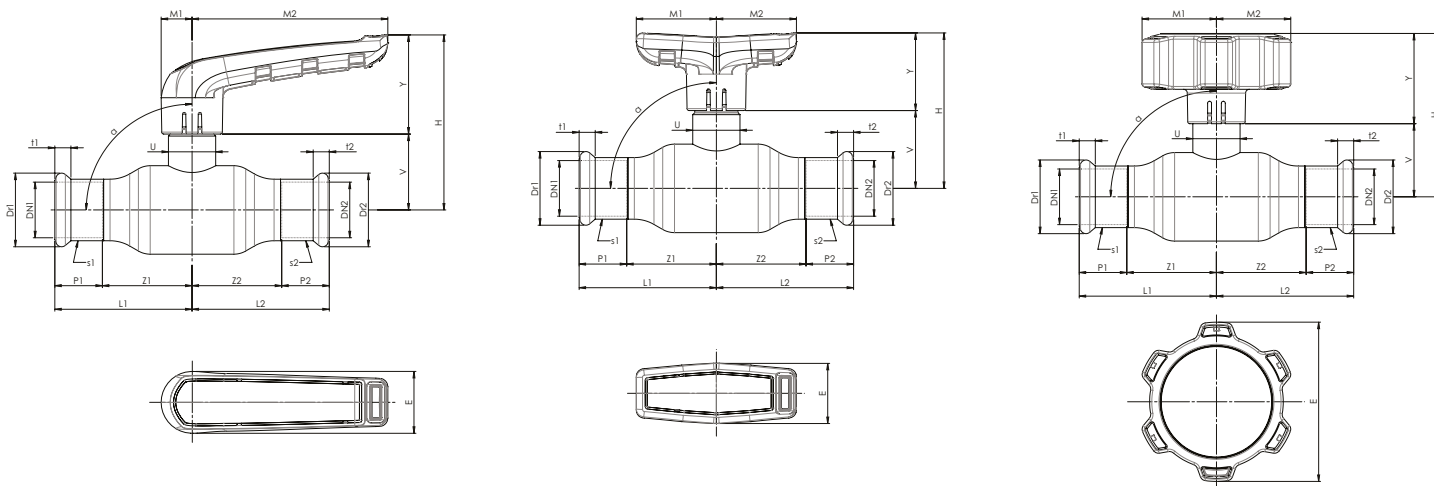

BROEN FULL FLOW DN10-50 | Pres × Pres

Pres × Pres Forzinket stål			BF101001 Lav spindel		BF101011 Høj Spindel	
L-greb	DN	Dim.	Varenr.	VVS-nr.	Varenr.	VVS-nr.
	DN10	15 × 15	1010000100-1100	418433315	1010000101-1100	418433615
	DN15	18 × 18	1015000100-1100	418433318	1015000101-1100	418433618
	DN20	22 × 22	1020000100-1100	418433322	1020000101-1100	418433622
	DN25	28 × 28	1025000100-1100	418433328	1025000101-1100	418433628
	DN32	35 × 35	1032000100-1100	418433335	1032000101-1100	418433635
	DN40	42 × 42	1040000100-1100	418433342	1040000101-1100	418433642
DN50	54 × 54	1050000100-1100	418433354	1050000101-1100	418433654	

Pres × Pres Forzinket stål			BF101004 Lav spindel		BF101014 Høj Spindel	
T-greb	DN	Dim.	Varenr.	VVS-nr.	Varenr.	VVS-nr.
	DN10	15 × 15	1010000100-1400	418433515	1010000101-1400	418433815
	DN15	18 × 18	1015000100-1400	418433518	1015000101-1400	418433818
	DN20	22 × 22	1020000100-1400	418433522	1020000101-1400	418433822
	DN25	28 × 28	1025000100-1400	418433528	1025000101-1400	418433828
	DN32	35 × 35	1032000100-1400	418433535	1032000101-1400	418433835

Pres × Pres Forzinket stål			BF101002 Lav spindel		BF101012 Høj Spindel	
Gear-greb	DN	Dim.	Varenr.	VVS-nr.	Varenr.	VVS-nr.
	DN10	15 × 15	1010000100-1200	418433415	1010000101-1200	418433715
	DN15	18 × 18	1015000100-1200	418433418	1015000101-1200	418433718
	DN20	22 × 22	1020000100-1200	418433422	1020000101-1200	418433722
	DN25	28 × 28	1025000100-1200	418433428	1025000101-1200	418433728
	DN32	35 × 35	1032000100-1200	418433435	1032000101-1200	418433735
	DN40	42 × 42	1040000100-1200	418433442	1040000101-1200	418433742
DN50	54 × 54	1050000100-1200	418433454	1050000101-1200	418433754	

BROEN FULL FLOW DN10-50 | Pres × Muffe

Pres × Muffe Forzinket stål			BF110001 Lav spindel		BF110011 Høj Spindel	
L-greb	DN	Dim.	Varenr.	VVS-nr.	Varenr.	VVS-nr.
	DN10	1/2" × 15	1010001010-1100	418434315	1010001011-1100	418434615
	DN15	3/4" × 18	1015001010-1100	418434318	1015001011-1100	418434618
	DN20	3/4" × 22	1020001000-1100	418434322	1020001001-1100	418434622
	DN25	1" × 28	1025001000-1100	418434328	1025001001-1100	418434628
	DN32	1 1/4" × 35	1032001000-1100	418434335	1032001001-1100	418434635
	DN40	1 1/2" × 42	1040001000-1100	418434342	1040001001-1100	418434642
	DN50	2" × 54	1050001000-1100	418434354	1050001001-1100	418434654

Pres × Muffe Forzinket stål			BF110004 Lav spindel		BF110014 Høj Spindel	
T-greb	DN	Dim.	Varenr.	VVS-nr.	Varenr.	VVS-nr.
	DN10	1/2" × 15	1010001010-1400	418434515	1010001011-1400	418434815
	DN15	3/4" × 18	1015001010-1400	418434518	1015001011-1400	418434818
	DN20	3/4" × 22	1020001000-1400	418434522	1020001001-1400	418434822
	DN25	1" × 28	1025001000-1400	418434528	1025001001-1400	418434828
	DN32	1 1/4" × 35	1032001000-1400	418434535	1032001001-1400	418434835

Pres × Muffe Forzinket stål			BF110002 Lav spindel		BF110012 Høj Spindel	
Gear-greb	DN	Dim.	Varenr.	VVS-nr.	Varenr.	VVS-nr.
	DN10	1/2" × 15	1010001010-1200	418434415	1010001011-1200	418434715
	DN15	3/4" × 18	1015001010-1200	418434418	1015001011-1200	418434718
	DN20	3/4" × 22	1020001000-1200	418434422	1020001001-1200	418434722
	DN25	1" × 28	1025001000-1200	418434428	1025001001-1200	418434728
	DN32	1 1/4" × 35	1032001000-1200	418434435	1032001001-1200	418434735
	DN40	1 1/2" × 42	1040001000-1200	418434442	1040001001-1200	418434742
	DN50	2" × 54	1050001000-1200	418434454	1050001001-1200	418434754

BROEN FULL FLOW DN10-50 | Pres × Nippel

Pres × Nippel Forzinket stål			BF112001 Lav spindel		BF112011 Høj Spindel	
L-greb	DN	Dim.	Varenr.	VVS-nr.	Varenr.	VVS-nr.
	DN10	1/2" × 15	1010001210-1100	418436315	1010001211-1100	418436615
	DN15	3/4" × 18	1015001210-1100	418436318	1015001211-1100	418436618
	DN20	3/4" × 22	1020001200-1100	418436322	1020001201-1100	418436622
	DN25	1" × 28	1025001200-1100	418436328	1025001201-1100	418436628
	DN32	1 1/4" × 35	1032001200-1100	418436335	1032001201-1100	418436635
	DN40	1 1/2" × 42	1040001200-1100	418436342	1040001201-1100	418436642
	DN50	2" × 54	1050001200-1100	418436354	1050001201-1100	418436654

Pres × Nippel Forzinket stål			BF112004 Lav spindel		BF112014 Høj Spindel	
T-greb	DN	Dim.	Varenr.	VVS-nr.	Varenr.	VVS-nr.
	DN10	1/2" × 15	1010001210-1400	418430503	1010001211-1400	418430803
	DN15	3/4" × 18	1015001210-1400	418430504	1015001211-1400	418430804
	DN20	3/4" × 22	1020001200-1400	418430506	1020001201-1400	418430806
	DN25	1" × 28	1025001200-1400	418430508	1025001201-1400	418430808
	DN32	1 1/4" × 35	1032001200-1400	418430510	1032001201-1400	418430810

Pres × Nippel Forzinket stål			BF112002 Lav spindel		BF112012 Høj Spindel	
Gear-greb	DN	Dim.	Varenr.	VVS-nr.	Varenr.	VVS-nr.
	DN10	1/2" × 15	1010001210-1200	418430403	1010001211-1200	418430703
	DN15	3/4" × 18	1015001210-1200	418430404	1015001211-1200	418430704
	DN20	3/4" × 22	1020001200-1200	418430406	1020001201-1200	418430706
	DN25	1" × 28	1025001200-1200	418430408	1025001201-1200	418430708
	DN32	1 1/4" × 35	1032001200-1200	418430410	1032001201-1200	418430710
	DN40	1 1/2" × 42	1040001200-1200	418430411	1040001201-1200	418430711
	DN50	2" × 54	1050001200-1200	418430412	1050001201-1200	418430712

BROEN FULL FLOW DN10-50 | Pres × Omløber

Pres × Omløber Forzinket stål			BF114001 Lav spindel		BF114011 Høj Spindel	
L-greb	DN	Dim.	Varenr.	VVS-nr.	Varenr.	VVS-nr.
	DN10	3/4" × 15	1010001410-1100	418435315	1010001411-1100	418435615
	DN15	3/4" × 18	1015001400-1100	418435318	1015001401-1100	418435618
	DN20	3/4" × 22	1020001410-1100	418435322	1020001411-1100	418435622
	DN25	1 1/4" × 28	1025001400-1100	418435328	1025001401-1100	418435628
	DN32	1 1/2" × 35	1032001400-1100	418435335	1032001401-1100	418435635
	DN40	1 3/4" × 42	1040001400-1100	418435342	1040001401-1100	418435642
	DN50	2 1/4" × 54	1050001400-1100	418435354	1050001401-1100	418435654

Pres × Omløber Forzinket stål			BF114004 Lav spindel		BF114014 Høj Spindel	
T-greb	DN	Dim.	Varenr.	VVS-nr.	Varenr.	VVS-nr.
	DN10	3/4" × 15	1010001410-1400	418435515	1010001411-1400	418435815
	DN15	3/4" × 18	1015001400-1400	418435518	1015001401-1400	418435818
	DN20	3/4" × 22	1020001410-1400	418435522	1020001411-1400	418435822
	DN25	1 1/4" × 28	1025001400-1400	418435528	1025001401-1400	418435828
	DN32	1 1/2" × 35	1032001400-1400	418435535	1032001401-1400	418435835

Pres × Omløber Forzinket stål			BF114002 Lav spindel		BF114012 Høj Spindel	
Gear-greb	DN	Dim.	Varenr.	VVS-nr.	Varenr.	VVS-nr.
	DN10	3/4" × 15	1010001410-1200	418435415	1010001411-1200	418435715
	DN15	3/4" × 18	1015001400-1200	418435418	1015001401-1200	418435718
	DN20	3/4" × 22	1020001410-1200	418435422	1020001411-1200	418435722
	DN25	1 1/4" × 28	1025001400-1200	418435428	1025001401-1200	418435728
	DN32	1 1/2" × 35	1032001400-1200	418435435	1032001401-1200	418435735
	DN40	1 3/4" × 42	1040001400-1200	418435442	1040001401-1200	418435742
	DN50	2 1/4" × 54	1050001400-1200	418435454	1050001401-1200	418435754

BROEN FULL FLOW DN10-50 | Muffe × Muffe

Muffe × Muffe Forzinket stål			BF120001 Lav spindel		BF120011 Høj Spindel	
L-greb	DN	Dim.	Varenr.	VVS-nr.	Varenr.	VVS-nr.
	DN10	3/8" × 3/8"	1010002000-1100	418430303	1010002001-1100	418430603
	DN15	1/2" × 1/2"	1015002000-1100	418430304	1015002001-1100	418430604
	DN20	3/4" × 3/4"	1020002000-1100	418430306	1020002001-1100	418430606
	DN25	1" × 1"	1025002000-1100	418430308	1025002001-1100	418430608
	DN32	1 1/4" × 1 1/4"	1032002000-1100	418430310	1032002001-1100	418430610
	DN40	1 1/2" × 1 1/2"	1040002000-1100	418430311	1040002001-1100	418430611
	DN50	2" × 2"	1050002000-1100	418430312	1050002001-1100	418430612

Muffe × Muffe Forzinket stål			BF120004 Lav spindel		BF120014 Høj Spindel	
T-greb	DN	Dim.	Varenr.	VVS-nr.	Varenr.	VVS-nr.
	DN10	3/8" × 3/8"	1010002000-1400	418432518	1010002001-1400	418432818
	DN15	1/2" × 1/2"	1015002000-1400	418432527	1015002001-1400	418432827
	DN20	3/4" × 3/4"	1020002000-1400	418432535	1020002001-1400	418432835
	DN25	1" × 1"	1025002000-1400	418432544	1025002001-1400	418432844
	DN32	1 1/4" × 1 1/4"	1032002000-1400	418432552	1032002001-1400	418432852

Muffe × Muffe Forzinket stål			BF120002 Lav spindel		BF120012 Høj Spindel	
Gear-greb	DN	Dim.	Varenr.	VVS-nr.	Varenr.	VVS-nr.
	DN10	3/8" × 3/8"	1010002000-1200	418436415	1010002001-1200	418436715
	DN15	1/2" × 1/2"	1015002000-1200	418436418	1015002001-1200	418436718
	DN20	3/4" × 3/4"	1020002000-1200	418436422	1020002001-1200	418436722
	DN25	1" × 1"	1025002000-1200	418436428	1025002001-1200	418436728
	DN32	1 1/4" × 1 1/4"	1032002000-1200	418436435	1032002001-1200	418436735
	DN40	1 1/2" × 1 1/2"	1040002000-1200	418436442	1040002001-1200	418436742
	DN50	2" × 2"	1050002000-1200	418436454	1050002001-1200	418436754

BROEN FULL FLOW DN10-50 | Muffe × Omløber

Muffe × Omløber Forzinket stål			BF122001 Lav spindel		BF122011 Høj Spindel	
L-greb	DN	Dim.	Varenr.	VVS-nr.	Varenr.	VVS-nr.
	DN10	1/2" × 3/8"	1010002200-1100	418432318	1010002201-1100	418432618
	DN15	3/4" × 1/2"	1015002200-1100	418432327	1015002201-1100	418432627
	DN20	3/4" × 3/4"	1020002210-1100	418432306	1020002211-1100	418432606
	DN20	1" × 3/4"	1020002200-1100	418432335	1020002201-1100	418432635
	DN25	1 1/4" × 1"	1025002200-1100	418432344	1025002201-1100	418432644
	DN32	1 1/2" × 1 1/4"	1032002200-1100	418432352	1032002201-1100	418432652
	DN40	2" × 1 1/2"	1040002210-1100	418432360	1040002211-1100	418432660
	DN50	2 1/4" × 2"	1050002200-1100	418432369	1050002201-1100	418432669

Muffe × Omløber Forzinket stål			BF122004 Lav spindel		BF122014 Høj Spindel	
T-greb	DN	Dim.	Varenr.	VVS-nr.	Varenr.	VVS-nr.
	DN10	1/2" × 3/8"	1010002200-1400	418432518	1010002201-1400	418432818
	DN15	3/4" × 1/2"	1015002200-1400	418432527	1015002201-1400	418432827
	DN20	1" × 3/4"	1020002200-1400	418432535	1020002201-1400	418432835
	DN25	1 1/4" × 1"	1025002200-1400	418432544	1025002201-1400	418432844
	DN32	1 1/2" × 1 1/4"	1032002200-1400	418432552	1032002201-1400	418432852

Muffe × Omløber Forzinket stål			BF122002 Lav spindel		BF122012 Høj Spindel	
Gear-greb	DN	Dim.	Varenr.	VVS-nr.	Varenr.	VVS-nr.
	DN10	1/2" × 3/8"	1010002200-1200	418432418	1010002201-1200	418432718
	DN15	3/4" × 1/2"	1015002200-1200	418432427	1015002201-1200	418432727
	DN20	1" × 3/4"	1020002200-1200	418432435	1020002201-1200	418432735
	DN25	1 1/4" × 1"	1025002200-1200	418432444	1025002201-1200	418432744
	DN32	1 1/2" × 1 1/4"	1032002200-1200	418432452	1032002201-1200	418432752
	DN40	2" × 1 1/2"	1040002210-1200	418432460	1040002211-1200	418432760
	DN50	2 1/4" × 2"	1050002200-1200	418432469	1050002201-1200	418432769

BROEN FULL FLOW DN10-50 | Muffe x Nippel

Muffe x Nippel Forzinket stål			BF124001 Lav spindel		BF124011 Høj Spindel	
L-greb	DN	Dim.	Varenr.	VVS-nr.	Varenr.	VVS-nr.
	DN10	3/8" x 3/8"	1010002400-1100	418431303	1010002401-1100	418431603
	DN15	1/2" x 1/2"	1015002400-1100	418431304	1015002401-1100	418431604
	DN20	3/4" x 3/4"	1020002400-1100	418431306	1020002401-1100	418431606
	DN25	1" x 1"	1025002400-1100	418431308	1025002401-1100	418431608
	DN32	1 1/4" x 1 1/4"	1032002400-1100	418431310	1032002401-1100	418431610
	DN40	1 1/2" x 1 1/2"	1040002400-1100	418431311	1040002401-1100	418431611
	DN50	2" x 2"	1050002400-1100	418431312	1050002401-1100	418431612

Muffe x Nippel Forzinket stål			BF124004 Lav spindel		BF124014 Høj Spindel	
T-greb	DN	Dim.	Varenr.	VVS-nr.	Varenr.	VVS-nr.
	DN10	3/8" x 3/8"	1010002400-1400	418431503	1010002401-1400	418431803
	DN15	1/2" x 1/2"	1015002400-1400	418431504	1015002401-1400	418431804
	DN20	3/4" x 3/4"	1020002400-1400	418431506	1020002401-1400	418431806
	DN25	1" x 1"	1025002400-1400	418431508	1025002401-1400	418431808
	DN32	1 1/4" x 1 1/4"	1032002400-1400	418431510	1032002401-1400	418431810

Muffe x Nippel Forzinket stål			BF124002 Lav spindel		BF124012 Høj Spindel	
Gear-greb	DN	Dim.	Varenr.	VVS-nr.	Varenr.	VVS-nr.
	DN10	3/8" x 3/8"	1010002400-1200	418431403	1010002401-1200	418431703
	DN15	1/2" x 1/2"	1015002400-1200	418431404	1015002401-1200	418431704
	DN20	3/4" x 3/4"	1020002400-1200	418431406	1020002401-1200	418431706
	DN25	1" x 1"	1025002400-1200	418431408	1025002401-1200	418431708
	DN32	1 1/4" x 1 1/4"	1032002400-1200	418431410	1032002401-1200	418431710
	DN40	1 1/2" x 1 1/2"	1040002400-1200	418431411	1040002401-1200	418431711
	DN50	2" x 2"	1050002400-1200	418431412	1050002401-1200	418431712

Our brand is our promise

BROEN
VALVE TECHNOLOGIES

BROEN Valve Technologies

BROEN er international markedsleder i ventilteknologi og vi er i dag repræsenteret på 3 kontinenter med høj aktivitet i Europa, Kina og USA.

I over 75 år har BROEN været en førende leverandør med udvikling og produktion af driftssikker og intelligent ventilteknologi til regulering af vand, luft og gas. BROEN leverer komplette løsninger inden for VVS-installationer og er førende leverandør af fjernvarmeventiler og ventiler til naturgas.

Med vores store erfaring og ekspertise omkring ventilteknologi skaber vi i tæt dialog med vores kunder og partnere over hele verden værdi og troværdighed og tilbyder pålidelige og sikre ventiler med fuld sikkerhed.

Læs mere her: www.broen.dk

Salgs- og produktionsenheder ●

BROEN A/S, Assens (DK)
BROEN POLEN, Dzierżoniów (PL)
BROEN POLEN, Rogoźno (PL)
BROEN INC., Houston (US)
BROEN Clorius, Dzierżoniów (PL)

Salgselskaber og kontorer ○

BROEN Assens (DK)
BROEN Helsinki (FI)
BROEN Beijing (CN)
BROEN Clorius, Shanghai (CN)

